

Model RGAC/SGAC Self Contained Cooling/ Gas Heating Units

Supersedes: 145.24-IOM1 (708)

Form 145.24-IOM1 (908)

RGAC AND SGAC INSTALLATION AND OPERATION INSTRUCTIONS

Models RGAC & SGAC-R22 Category III Gas Heating / Electric Cooling Units

Models RGAC & SGAC Capacities*
12,000, 18,000, 24,000 & 36,000 Btu/Hr. Cooling
20,000, 40,000, 60,000 & 80,000 Btu/Hr. Input Heating

*Not all cooling capacities available in all heating capacities.



IMPORTANT!

READ BEFORE PROCEEDING!

GENERAL SAFETY GUIDELINES

This equipment is a relatively complicated apparatus. During installation, operation, maintenance or service, individuals may be exposed to certain components or conditions including, but not limited to: refrigerants, oils, materials under pressure, rotating components, and both high and low voltage. Each of these items has the potential, if misused or handled improperly, to cause bodily injury or death. It is the obligation and responsibility of operating/service personnel to identify and recognize these inherent hazards, protect themselves, and proceed safely in completing their tasks. Failure to comply with any of these requirements could result in serious damage to the equipment and the property in

which it is situated, as well as severe personal injury or death to themselves and people at the site.

This document is intended for use by owner-authorized operating/service personnel. It is expected that this individual possesses independent training that will enable them to perform their assigned tasks properly and safely. It is essential that, prior to performing any task on this equipment, this individual shall have read and understood this document and any referenced materials. This individual shall also be familiar with and comply with all applicable governmental standards and regulations pertaining to the task in question.

SAFETY SYMBOLS

The following symbols are used in this document to alert the reader to areas of potential hazard:



DANGER indicates an imminently hazardous situation which, if not avoided, will result in death or serious injury.



CAUTION identifies a hazard which could lead to damage to the machine, damage to other equipment and/or environmental pollution. Usually an instruction will be given, together with a brief explanation.



WARNING indicates a potentially hazardous situation which, if not avoided, could result in death or serious injury.

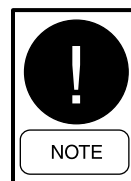

NOTE is used to highlight additional information which may be helpful to you.



All wiring must be in accordance with published specifications and must be performed ONLY by qualified service personnel. Johnson Controls will not be responsible for damages/problems resulting from improper connections to the controls or application of improper control signals. Failure to follow this will void the manufacturer's warranty and cause serious damage to property or injury to persons.

CHANGEABILITY OF THIS DOCUMENT

In complying with Johnson Controls policy for continuous product improvement, the information contained in this document is subject to change without notice. While Johnson Controls makes no commitment to update or provide current information automatically to the manual owner, that information, if applicable, can be obtained by contacting the nearest Johnson Controls service office.

It is the responsibility of operating/service personnel as to the applicability of these documents to the equipment in question. If there is any question in the mind of operating/service personnel as to the applicability of these documents, then, prior to working on the equipment, they should verify with the owner whether the equipment has been modified and if current literature is available.



Work on this equipment should only be done by properly trained personnel who are qualified to work on this type of equipment. Failure to comply with this requirement could expose the worker, the equipment and the building and its inhabitants to the risk of injury or property damage.

The instructions are written assuming the individual who will perform this work is a fully trained HVAC & R journeyman or equivalent, certified in refrigerant handling and recovery techniques, and knowledgeable with regard to electrical lock out/tag out procedures. The individual performing this work should be aware of and comply with all national, state and local safety and environmental regulations while carrying out this work. Before attempting to work on any equipment, the individual should be thoroughly familiar with the equipment by reading and understanding the associated service literature applicable to the equipment. If you do not have this literature, you may obtain it by contacting a Johnson Controls Service Office.

Should there be any question concerning any aspect of the tasks outlined in this instruction, please consult a Johnson Controls Service Office prior to attempting the work. Please be aware that this information may be time sensitive and that Johnson Controls reserves the right to revise this information at any time. Be certain you are working with the latest information.

TABLE OF CONTENTS

1. Preparing to Install Furnace	x	18. Furnace Section Start-Up Checklist	x
2. Important Safety Rules	x	19. Checking Controls	x
3. Meeting Codes	x	20. Checking inlet Gas Pressure	
4. Unpacking.....	x	& Pilot Adjustment	x
5. Installation Location.....	x	21. Adjusting Manifold Pressure.....	x
Cabinet Clearances	x	22. Checking Gas Input.....	x
Venting Requirements	x	23. Orifice Size	x
6. Wall Opening	x	24. Derating For High Altitudes.....	x
7. Wall Sleeve.....	x	25. System Balance.....	x
8. Unit to Sleeve Attachment	x	26. Measuring Air Temperature Rise	x
9. Installing Duct Work.....	x	27. Maintaining Furnace in Good Working Order..	x
10. Return Air Duct & Filter Arrangement.....	x	28. Getting Information & Publications	x
11. Combustion Air Supply	x	29. Refrigerant Charges	x
12. Filter Rack Installation	x	30. Wiring Conection Diagram.....	x
13. Installing Gas Piping.....	x	31. Schematic Connection Diagram.....	x
14. Condensate Drain Piping.....	x	32. Ignition System Troubleshooting	x
15. Electrical Connections.....	x	33. Direct Vent Clearances.....	x
16. Installing Electrical Wiring.....	x		
17. Sequence of Operation.....	x		

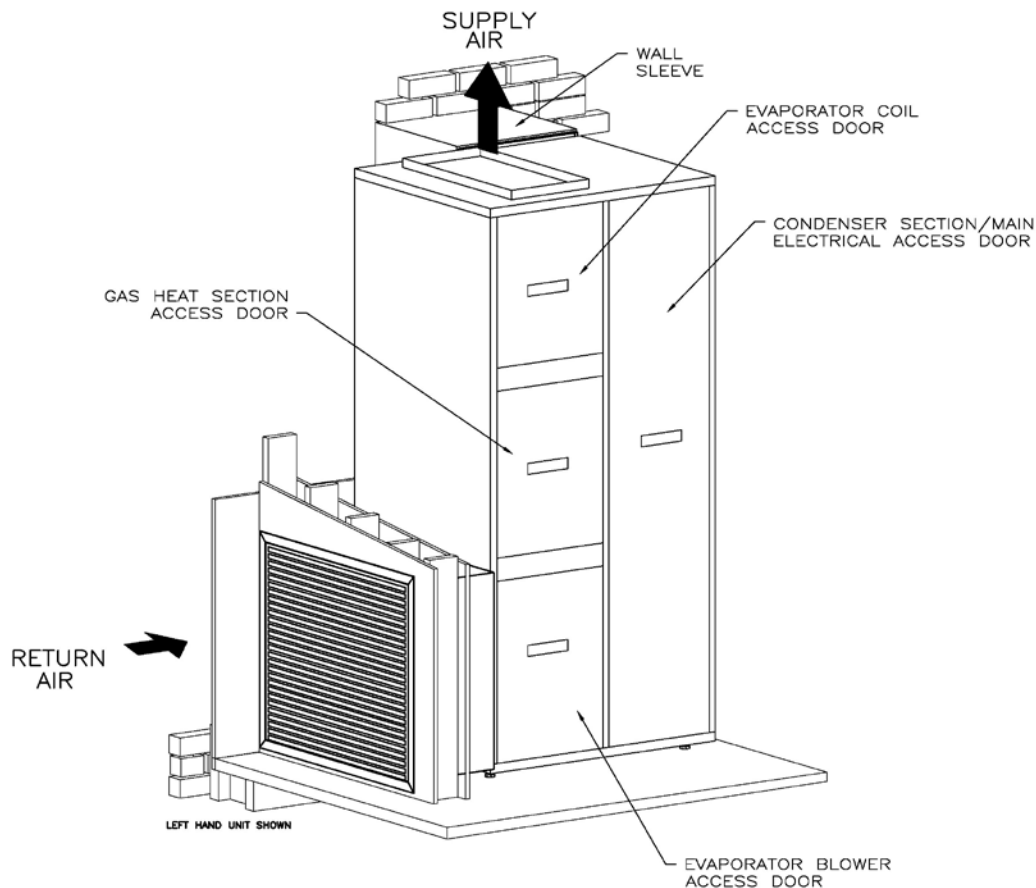

LD13220

To assure both safe and proper operation, please carefully follow the instructions in this manual to correctly install this new furnace.

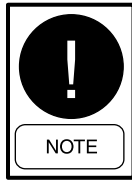

INSTALLER! After installing furnace, ensure that the user receives:

- 1) Users' Information Manual / Maintenance & Service Manual
- 2) Operation & Installation Instructions
- 3) Warranty Information Card

USER! Your furnace installer should give you the above important documents relating to your furnace. Keep these as long as you keep your furnace. Pass these documents on to later furnace purchases or Users. Throughout this Installer's Information Manual, we frequently use the word "you" when referring to the person responsible for application, installation and service of your furnace. Please remember to have only qualified service technicians perform these services.

IMPORTANT SAFETY NOTE: After installing the furnace, show the user how to turn off the electricity to furnace. Point out control and switch locations for turning off the electricity. Go over Section 3 and 5 of Users' Information Manual and Page 17 (Maintenance) in this manual with user. Make sure user understands the importance of following all safety precautions.

1. PREPARING TO INSTALL FURNACE

Literature - Review the Manual, Users' Manual Information & Parts List. In particular, see Users' Information Manual & Parts List for location and identification of furnace components.

After installing furnace, give this Installer's Information Manual Users' Information Manual, Warranty & Parts List to user. You may have questions as you install the furnace. If you need help on any of the installation instructions or other matters relating to the furnace, contact the office where you bought the furnace. You may also refer to the furnace rating plate for a contact name.

2. IMPORTANT SAFETY RULES



Only use natural gas in furnaces designated for natural gas. Only use Propane (LP) gas in furnace designed for Propane (LP) gas. Make sure furnace will operate properly on gas type available to user. Do not use this furnace with butane. Using an incorrect gas supply could create a hazard, resulting in damage, injury, or death.

- A.** Use only the type of gas approved for this furnace; refer to furnace rating plate.
- B.** Install this furnace only in a location and position as specified in Section 5 & 31 of these instructions.
- C.** Provide for adequate combustion and ventilation air to the furnace by installing only as detailed in Sections 5, 6, & 7.
- D.** Combustion products must be discharged outdoors. Connect this furnace to the approved, factory supplied, vent system only. Vent installation must be as specified in Section 8 of these instructions.
- E.** Never test for gas leaks with an open flame. Use a commercial soap made specifically for the detection of leaks to check all connections as specified in Section 13 of these instructions.
- F.** Always install furnace to operate within the furnace's intended temperature rise range with a duct system that has an external static pressure within the allowable range, as specified in Sections 10 & 26 of these instructions. See rating plate.
- G.** When a furnace is installed so that supply ducts carry air circulated by the furnace to areas outside the space containing the furnace, the return air shall also be handled by duct(s) sealed to the furnace casing and terminating outside the space containing the furnace.
- H.** A gas-fired furnace for installation in a residential garage must be installed as specified in Section 6 of these instructions.
- I.** This furnace is NOT to be used for temporary heating of buildings or structures under construction.

3. MEETING CODES

This furnace complies with American National Standard ANSIZ21.47; CSA-2.3 Gas-Fired Central Furnaces, and is certified for operation with either natural gas or propane (LP) gas for indoor installation in a building constructed on site. It meets the requirement for a 100% shutoff gas control system.

Before installing furnace, make sure you know all applicable codes. National, state and local codes may take precedence over any instructions in this manual. Be sure to consult:

- Authorities having jurisdiction over furnaces;
- Local code authorities for information on electrical wiring.

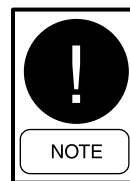

In the Commonwealth of Massachusetts, this product must be installed by a licensed plumber, or licensed gas fitter.

Accepted for Use -

City of New York, Department of Buildings
MEA # 394-94-E

Wisconsin Building Products Evaluation # 200102-H

Commonwealth of Massachusetts – Division of Registration

Approval Code # G3-0303-73

4. CORROSIVE VAPORS

Do NOT install furnace in a corrosive or contaminated atmosphere. Corrosive vapors in the atmosphere such as chlorinated hydrocarbons, will affect the operation of this unit. Do NOT store open containers of chlorine, bleach or other household cleaners near the furnace.

5. UNPACKING

- i) Check the unit for indications of damage in shipment. Notify the Transportation Company of any damage and note the damage on the shipping receipt.



Rough handling may dislocate internal components.

- ii) Allow the shipping base to remain with the unit until it is ready to be set in its final location.
- iii) Rotate blowers to assure free movement.
- iv) The compressor is mounted on neoprene isolators with metal spacing sleeves inside and secured with nuts that must be snug against the metal spacer sleeves.
- v) Check all refrigeration tubing to assure that it does not rub against any other parts.

6. NORMAL INSTALLATION

DO NOT install this furnace outdoors or in a mobile home, trailer or recreational vehicle. It is not design-certified for these installations. This furnace is suitable for a home built on site or a manufactured home completed at final site.

This unit is designed for indoor installation adjacent to an exterior wall having an opening for condenser airflow. The air flow products must:

- a) Discharge directly to the outside.
- b) Discharge away from any obstructions that could cause discharged air recirculation.

DO NOT install this unit at an exterior wall location that will position the bottom of the wall grille below the exterior grade level. Below grade installation will allow the accumulation of rain or snow into the wall sleeve and unit base, and could result in water penetration into the building interior.

A. CABINET CLEARANCES

The unit is design certified for closet installation with the minimum clearances to combustible materials as stated on the data label. No clearance is required from the top, sides, or back of the unit. A minimum of 1-inch clearance is required from the front to any combustible materials. A combustible door may be placed 1 inch from the front of the unit. When the door is open there must be 30 inches clearance to any obstruction, to allow sufficient access for service and the replacement of parts.

See Sections 10 & 12 regarding return air duct connections to the unit and provision for service access. The unit shall not be installed directly on carpeting, tile or other combustible material other than wood flooring.



When installed in a residential garage, the entire burner / heat exchanger section of the furnace must be at least 18 inches above the floor. The unit must be located or protected or avoid physical damage by vehicles.

B. VENTING REQUIREMENTS

The unit is approved as a **DIRECT VENT APPLIANCE**. Combustion air, and the discharged flue gas products, are drawn and discharged directly to the outside of the building through the wall sleeve. **DO NOT CONNECT THIS FURNACE TO ANY FLUE PIPE OR CHIMNEY.**

The location of the unit side wall vent termination, with respect to other wall penetrations, must comply with the applicable requirements of the U.S. National Fuel Gas Code (ANSI Z223.1/NFPA 54) or the Canadian Natural Gas and Propane Installation Code (CSA-B149.1).

The minimum required clearances to the flue vent termination are summarized in Section 32 - DIRECT VENT TERMINAL CLEARANCES. Review this section thoroughly prior to determining the final location of the furnace.

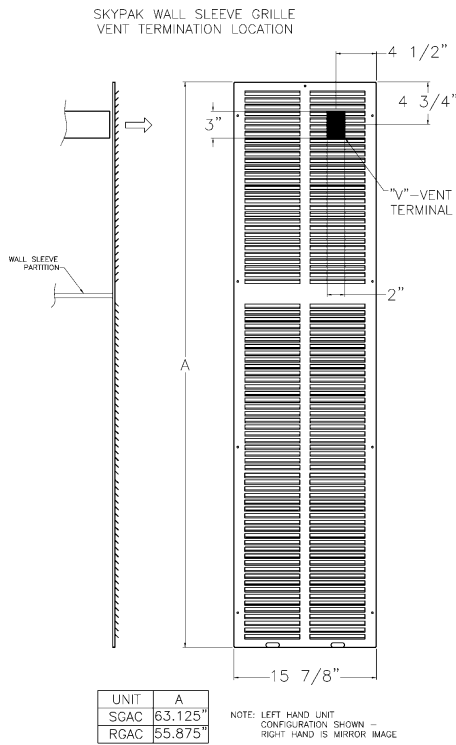

Fig. #1 - VENT TERMINAL

7. WALL OPENING

A finished opening through an outside wall is required for exhausting flue products and condenser airflow. The wall opening required is 16" wide by 56" high for R models and 16" wide by 63" high for S models. The wall opening must be flush with the finished floor.

Consult local ordinances for framing requirements of the building wall opening.

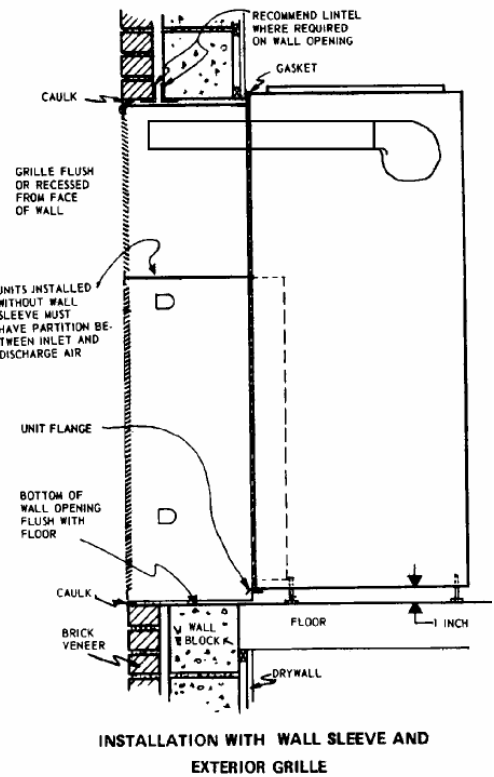

Fig. #2 - INSTALLATION W/ WALL SLEEVE AND EXTERIOR GRILLE

8. WALL SLEEVE

A wall sleeve is required to finish the wall opening. A factory-made wall sleeve is available as an optional accessory for new construction. When replacing a FEDDERS unit with a retrofit model "R", the "R" unit will mate with the existing FEDDERS wall sleeve. Use a spirit level or plumb line to make sure that the wall sleeve vertical flanges, which must mate with the back of the unit, are perfectly vertical. If the flanges are not vertical, the unit will not seal properly against the wall sleeve.



Completely seal any gaps or openings around the wall sleeve and the wall opening (use exterior grade caulking or expanding foam sealant), to prevent air and weather penetration into the building envelope.

EXTERIOR GRILLE

Finish the sleeve exterior with a factory grille. The sleeve, grille and vent terminal should be factory supplied.

9. UNIT TO SLEEVE ATTACHMENT & INSTALLATION OF VENT PIPE EXTENSION

Before the unit is moved into final position and attached to the wall sleeve, the ventor pipe extension must be installed. The vent pipe extension is shipped loose in the blower compartment at the bottom of the unit. The vent pipe extension must be cut to length depending on the depth of the wall sleeve used. When installed, the outlet end of the pipe must be 1 to 1 ¼ inches from the back of the exterior wall grille. The required length of the pipe extension is ½ inch less than the depth of the wall sleeve used. Measure the required length from the end that has pre-drilled screw holes and cut the surplus off the other end. The pipe extension must be installed before the furnace is in final position and attached to the wall sleeve. Secure the pipe extension to the ventor discharge pipe with two #10 x ½ inch self drilling hex head sheet metal screws, using the pilot holes provided.

A roll of 1 inch wide x ¼ inch thick self-adhesive sponge rubber gasket is packed in the blower compartment of the Skypak unit, to be used for sealing between the wall sleeve and the unit. Before moving the unit into final position, apply the self-adhesive gasket to all mating flanges on the wall sleeve.

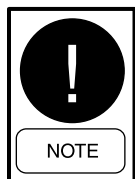

Ensure to apply gasket material to the horizontal divider panel flange between the top and bottom sections of the wall sleeve. Apply two layers of gasket tape at this location to ensure a satisfactory seal. Should this joint not have a good seal, rainwater may accumulate in the bottom of the unit.

Apply gasket material to the top surface of the horizontal lip, located at the bottom of the wall sleeve.

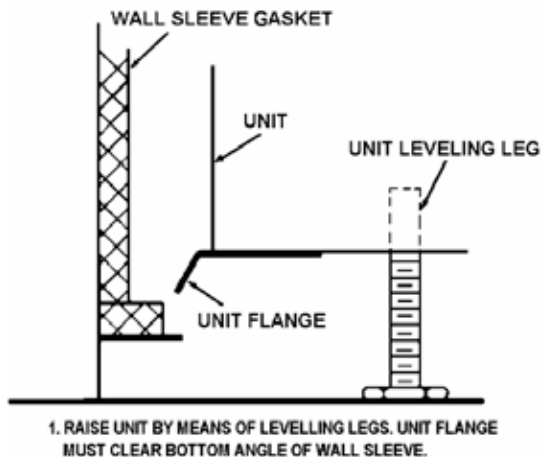

Raise the unit by screwing down the three leveling screws, until the flange at the bottom of the condenser is above the flange at the bottom of the wall sleeve.

Move the unit forward until the unit contacts the wall sleeve and makes a seal with the gasket on the wall sleeve. Lower the unit by means of the three leveling legs until the unit bottom flange is resting on the wall sleeve bottom flange and the gasket is compressed. Then use the front two leveling screws only to level the unit.

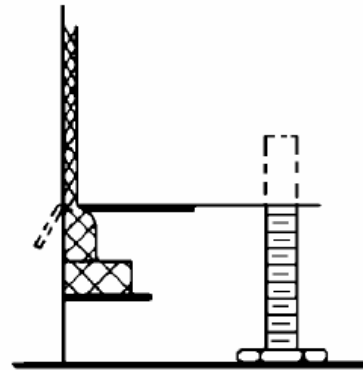

2. SLIDE UNIT INTO CONTACT WITH WALL SLEEVE. UNIT FLANGE MUST BE INSIDE WALL SLEEVE.

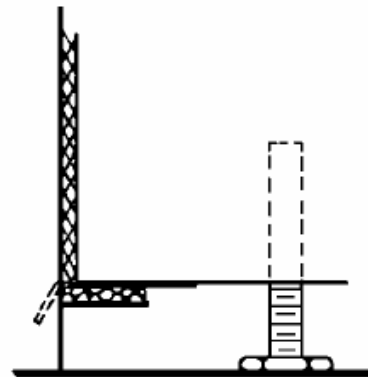

The "S" series units are secured to the wall sleeve by installing two #10 x ½ inch self drilling sheet metal screws through the flange standing up at the back of the unit top. These two screws will screw into the wall sleeve. The "R" series units are secured to the wall sleeve using a piece of angle 13/8 inch x 13/8 inch x 16 inches long. This angle should be placed on the top of the unit at the back with one flange facing down and clipping over the vertical flange at the top of wall sleeve. Then screw this piece of angle to the top of the unit using two #10 x ½ inch self-drilling sheet metal screws. The required piece of angle and screws are packed inside the blower compartment of "R" series units.

10. INSTALLING DUCT WORK



Install all ductwork to meet current standard:

- ASHRAE/NFPA 90, Standard for Installation of Warm Air Heating and Air Systems.
- State, provincial, and local codes

Failure to follow these standards could reduce airflow or increase air leakage, resulting in reduced system performance or furnace damage.

Properly size ductwork based on heat loss and heat gain calculations. Doing so assures:

- Good heating and cooling installations.
- Potentially fewer callbacks.
- Delivery of required circulating air.

For all furnaces, design systems for minimum and maximum external static pressures detailed in Figure 3. See Section 26 on measuring ductwork static pressure.

EXTERNAL STATIC PRESSURE (Inches of Water Column)		
*Input (BTU/HR)	Minimum	Maximum
20,000	0.10	0.30
40,000	0.10	0.30
60,000	0.12	0.30
80,000	0.12	0.30

*Input is on furnace rating plate on blower door
Fig. #3

SUPPLY AIR DUCT WORK

Connect supply air duct to 1-in. flange on furnace supply-air outlet. Duct attaching hardware only must be used on the supply-air outlet flanges. Refrigeration tubing is located under the top panel near these flanges. Do not drill or screw in this area.

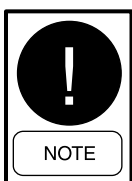

Supply air duct (plenum) connection must be at least the same size as the furnace supply air opening. Seal supply air ductwork to furnace casing, walls, ceilings or floors it passes through. Terminate ductwork outside furnace space.

DUCT DAMPERS

You may balance air flow with dampers installed in each branch run duct and adjust for even temperature throughout the heated space. For proper furnace operation, make sure:

- Supply air registers and return air grilles are open.
- Rugs, carpets, drapes or furniture are clear of registers and grilles;
- Size and shape of supply air plenum is correct;
- Number of supply air duct outlets is sufficient;

11. COMBUSTION AIR SUPPLY

The unit is approved as a DIRECT VENT APPLIANCE. This furnace draws all combustion air from outdoors. There is no need to provide combustion or ventilation air openings, except as may be required by local codes.

- All service access panels must be in place for the furnace to properly draw in outside combustion air.



When installing furnace in an alcove, basement, closet, garage, or utility room do not store items in front of furnace or in front of closet or utility door which would prevent ready access for service.

12. FILTER RACK INSTALLATION FOR SIDE RETURN



Air filters are required to keep the air conditioning coil and blower motor clean. Dirty equipment may cause damage to the heat exchanger or air conditioning unit. The filter frame is provided for an 18 in. X 25 in. X 1 in. filter. The filter frame has to be field installed, after snipping out the prepunched opening in the side of the unit.

Position the three-sided filter frame so that the short side is towards the back of the furnace and the 1-inch duct flange is facing outwards. The long sides of the frame should be pulled slightly towards each other, so that the continuous slip formed on the back of the frame clears the opening in the cabinet. Push the frame towards the back of the unit firmly until the short vertical part of the frame clips onto the cabinet. Then insert the other vertical side of the frame between the ends of the top and bottom parts of the frame. This will keep the top and bottom parts of the frame clipped into position. If there is difficulty getting the front vertical piece installed. Remove the entire filter frame and trim off any burns left where the opening was snipped out.

ALTERNATIVE FILTER ARRANGEMENTS

On 1 and 1-½ ton units only, a filter frame to hold a 14 x 20 x 1 inch disposable filter may be fitted to the front of the blower compartment, in place of the access door. The filter frame and a section of the return duct connected to it must be easily removable, to allow room for removal of the blower and motor assembly.

BOTTOM RETURN PLENUMS

When a bottom return plenum is used, snip out the prepunched 11 x 20 inch opening in the bottom of the cabinet. On bottom return applications, a wire frame and media retaining clips are provided for installation of a 'hammock' style filter.

MEDIA SIZES FOR BOTTOM RETURN

Unit Size	Filter Size
R-Series	25" x 26" x 1"
S-Series	25" x 28" x 1"

There are no filters supplied with this unit. The installing contractor must provide and install the recommended size filters.

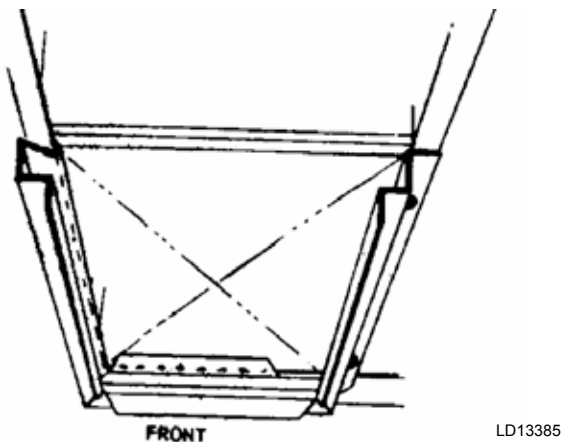
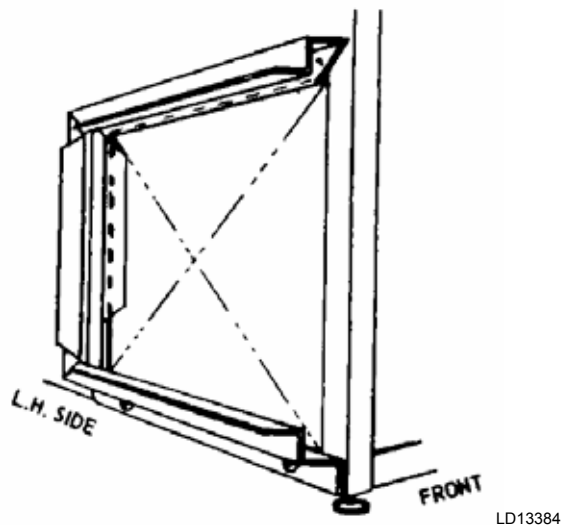

13. INSTALLING GAS PIPING



FIRE OR EXPLOSION HAZARD: Failure to follow the safety warnings exactly could result in serious injury, death or property damage. Never test for gas leaks with an open flame. Use a commercially available soap solution made specifically for the detection of leaks to check all connections. A fire or explosion may result causing property damage, personal injury or loss of life.

A. Preparation

Gas piping must meet requirements of current National Fuel Gas Code ANSE Z223.1/ or CAN/CGA B149 and local codes. Size of pipe running to furnace depends on:

- Length of pipe;
- Number of fittings;
- Specific gravity of gas;
- Input requirements (Btuh) of all gas-fired appliances attached to same main supply line.

Plan furnace gas supply piping so it will not interfere with removal of burner assembly, front door or blower door for servicing.

Always use a pipe thread sealant that is resistant to propane (LP) gas solvent action. Sparingly apply sealant to all joints on male threads only, starting two threads back from end.

B. Furnace Gas Entry Piping

A hole and a rubber grommet are provided in the side of the cabinet for connecting ½ inch gas pipe to the gas control. The gas piping connection is always on the opposite side of the cabinet to the furnace and return air connection.

If there is not enough room to run gas piping down the side of the unit, it is possible to have the gas pipe entry through the top of the cabinet. Knockouts are provided in the top panel for this purpose.

C. Installation

1. Install A.G.A./C.G.A. listed manual shut-off valve in gas supply line immediately upstream of furnace. Install 1/8" NPT plugged tapping immediately upstream of furnace. Omit separate, plugged tapping if local area accepts plugged tapping in gas control inlet.
2. After in-line manual shut-off valve, install a drip leg (sediment trap) at gas supply line inlet connection to furnace.

3. When using black iron gas pipe*, install an A.G.A./C.G.A. listed ground joint union between drip leg (sediment trap) and furnace gas control. Locate ground joint union down-stream of manual shutoff valve to allow easy servicing of burner assembly and gas control.

*If local codes allow the use of a flexible gas connector, always use a new listed connector. DO NOT use a connector that has previously serviced another gas appliance.

4. Install gas pipe to inlet side of furnace gas control.



Do not thread gas pipe too far into control valve body. Doing so may cause gas control to split or crack which could cause a gas leak or distortion or malfunction of gas control. These could cause a fire or explosion resulting in damage, injury or death.

5. Isolate gas control from gas supply line pressure during leak check. Gas supply line test pressure determines how you isolate gas control.



At gas supply line, test pressure equal to or less than 14 inches W.C. (1/2 PSI), isolate gas control from gas supply line by sliding furnace gas control switch to off position. Unexpected surges could damage gas control causing gas leak, resulting in fire or explosion.

When test pressure is above 14 inches W.C. (1/2 PSI), completely disconnect gas control from gas supply line. Failure to isolate gas control test pressure could damage it, causing gas leak, resulting in fire or explosion.

6. Use a commercial soap solution made to detect leaks and check all gas piping

14. CONDENSATE DRAIN PIPING

The condensate drain pan is fitted with a 3/4" NPT female pipe fitting which protrudes through the unit casing. The 3/4" drain piping should be run horizontally from this fitting, until the piping is past the side of the unit casing and not passing in front of any of the access doors. Once the piping is clear of the unit casing, a trap should be installed to prevent conditioned air from being blown out of the drain line. The trap should be at least 2 inches deep, with the outlet a minimum of 1/2 inch below the inlet. The drain piping on the outlet side of the trap

should be pitched 1/4 inch per foot down towards an open drain. Unions should be installed between the unit and the trap, and on the outlet side of the trap to allow for disconnecting the piping and the trap for cleaning out.

15. ELECTRICAL CONNECTIONS

Check the voltage and phase listed on the unit rating plate, before installation; to be sure the power supply is correct. If the compressor fails as the result of improper voltage, the compressor is not replaceable under warranty and the manufacturer will not be responsible for the cost of replacement. The minimum and maximum operating voltages, and fuse sizes, are listed on the unit rating plate.

The power leads must be brought to the entry knockouts provided in the unit control box through a customer supplied fused disconnect switch placed within sight of the unit.

Ensure that the furnace shall be installed so that all wiring and electrical components are protected from water.

16. INSTALLING ELECTRICAL WIRING



Provide furnace with its own separate electrical circuit, means of circuit protection and electrical disconnect switch. Follow current National Electrical Code ANSI/NFPA 70, CSA C22.1 C.E.C. Part 1, and state and local codes. Failure to provide these shut-off means could cause electrical shock or fire, resulting in damage, injury or death.

Furnace must have proper electrical ground. Failure to provide a proper electrical ground could cause electrical shock or fire, resulting in damage, injury or death.

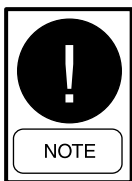

All field-connected wiring shall be suitable for a minimum 63°F (35°C) temperature rise.

Field and internal wiring diagrams are attached to the back of the compressor compartment access door.

Select a location for room thermostat that is away from supply air registers, on draft-free interior wall, and not near lights, television, direct sunlight, or other heat sources. Install thermostat following field wiring diagram, Figure #5.

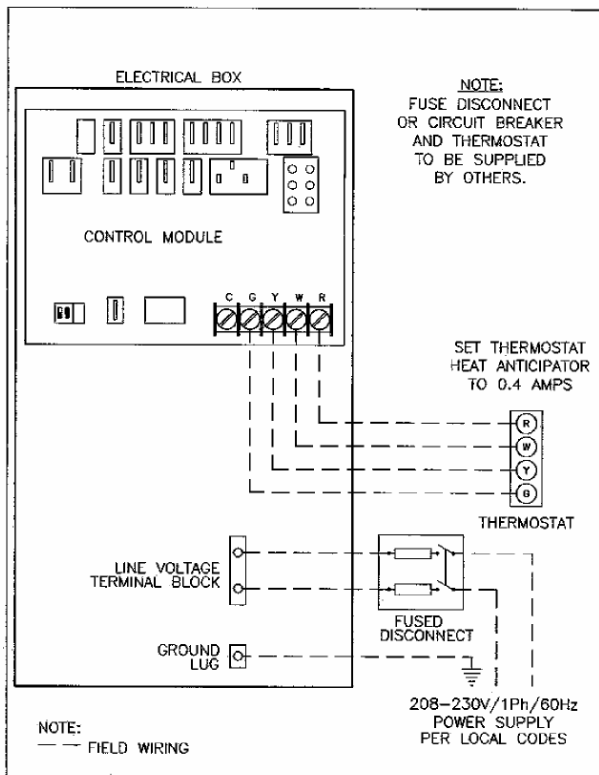

LD13386

Fig. #5 - FIELD WIRING DIAGRAM**THERMOSTAT OPERATION**

Heating Operation: Turn system switch to "Heat" and "Fan" switch to "Auto". Set thermostat at desired temperature.

Cooling Operation: Turn system switch to "Cool" and "Fan" switch to "Auto". Set thermostat at desired temperature.

Blower Operation: To recirculate indoor air, turn "Fan" switch to "On" and system switch to "Off".

Unit Off: Turn system switch "Off" and fan switch "Auto". Burner ignition is automatic with next heating cycle.



Thermostats with heat anticipators should have the heat anticipator set for 0.40 AMPS.

17. SEQUENCE OF OPERATION ON HEATING CYCLE

- 1) Room thermostat calls for heat, connecting R to W terminals on fan timer control module ST9120G2032.
- 2) Ventor motor starts & vacuum switch normally open contacts close.
- 3) The pilot gas valve & the igniter are energized.
- 4) When a flame signal is detected at the pilot burner, the main gas valve opens, the main burners ignite, and the hot surface igniter is de-energized. The main burners normally ignite within five seconds after the call for heat.
- 5) The air-circulating fan starts thirty seconds after the main burners ignite.
- 6) When the room thermostat is satisfied, terminal W on the module is de-energized.
- 7) The main and pilot valves in the gas control are de-energized.
- 8) The ventor motor is de-energized after a 5-second post purge period.
- 9) The air-circulating fan is de-energized after the off delay timing which is factory set at 60 seconds. The off delay is adjustable between 60 & 180 seconds. Increasing the off delay will cause cold drafts and is not recommended.

SEQUENCE OF OPERATION ON COOLING CYCLE

- 1) Room thermostat calls for cooling connecting R to Y terminals on fan timer control module ST9120G2032.
- 2) The compressor and condenser fan start immediately on a call for cooling.
- 3) Air circulating fan starts after a four-second delay.
- 4) When the room thermostat is satisfied, terminal Y on the module is de-energized.
- 5) The compressor and condenser fan stop immediately when the thermostat is satisfied.
- 6) The air circulating fan continues to run for an off delay period of 100 seconds. The off delay is not adjustable on the cooling cycle.

HEATING SEQUENCE OF OPERATION DIAGRAM

CAUTION:

1. Do not apply a jumper across or short the thermostat, 24V hot or 24V common terminal in the SV9501 wiring harness. Doing so can burn out the heat anticipator in the thermostat or damage the system transformer.
2. After servicing, verify proper system operation.

Sequence of Operation

1. Make sure the ignition system control switch is in the ON position.
2. Follow the sequence of operation as shown.

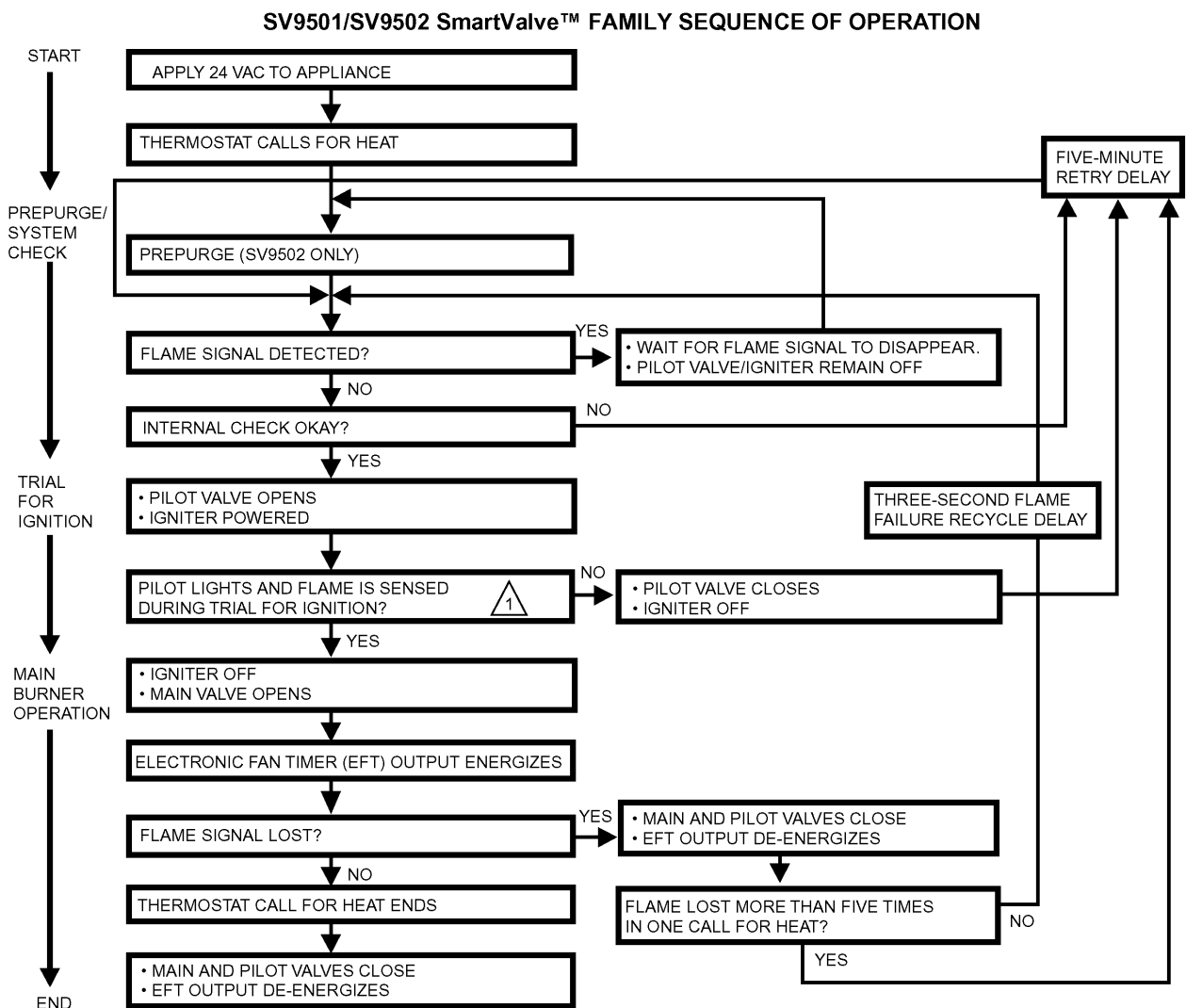

1 IGNITER WILL TURN OFF ABOUT 30 SECONDS INTO THE TRIAL FOR IGNITION IF THE PILOT FLAME HAS NOT LIT. IT WILL TURN BACK ON FOR THE FINAL 30 SECONDS OF THE 90 SECOND TRIAL FOR IGNITION. THE PILOT VALVE WILL BE ENERGIZED DURING THE ENTIRE TRIAL FOR IGNITION. THIS IS NORMAL OPERATION FOR THIS GAS IGNITION SYSTEM.

M17144

If Main Burner Will NOT Come On With Call for Heat

1. Make sure the ignition system control switch is in the ON position.
2. Adjust the thermostat several degrees above room temperature.
3. Using ac voltmeter, check for 24V at the ignition system control as shown in the troubleshooting guide.

18. FURNACE SECTION START-UP CHECKLIST

Before starting furnace for the first time, be sure you can answer “Yes” to each of these questions:

- Is furnace properly equipped to operate with available fuel?
- Is the furnace level?
- Have you cleared away all loose construction and insulation materials?
- Is furnace installed within proper clearances to combustible materials? See Section 6A.
- Did you completely check gas pipe and controls for gas leaks? See Section 13, “C”, Item 6.
- Does electrical wiring follow current National Electrical Code ANSI or CSA C22.1 C.E.C. Part 1 as well as local codes? See Section 16.
- Is furnace electrically grounded?
See Section 16.
- Is room thermostat properly installed?
See Section 16.
- Is ductwork system correctly sized and sealed?
See Section 10.
- Are air filters in place and correctly sized? See Section 12.
- On furnace installations above a 2000-foot elevation, is furnace derated properly?
See Section 24.

19. CHECKING CONTROLS

Before leaving the work site, check to see that all controls are functioning properly.

Follow these steps:

1. Turn off electricity at electrical disconnect switch next to furnace.
2. Move gas control slide switch to OFF position.
3. Connect a “U” tube water manometer to gas control outlet (manifold) pressure tap.
4. Set room thermostat to its highest temperature.
5. Turn on electricity at electrical disconnect switch located next to furnace.
6. Draft inducer should run and pilot igniter should glow but pilot burner should not light. Manifold pressure should remain at zero.
7. Turn off electricity at electrical disconnect switch located next to furnace. Move gas control slide switch to ON position.

8. Turn on electricity at electrical disconnect switch located next to furnace. Draft inducer should run, pilot igniter should glow, and pilot burner should light and ignite main burners. Wait 30 seconds after main burner ignition for main blower to start.

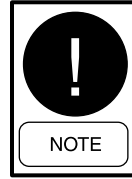

To purge gas lines, it may be necessary to wait several minutes for the pilot burner to light.

9. Cycle electrical disconnect switch next to furnace on and off. Watch at least three ignition cycles. Pilot should ignite main burners smoothly.
10. Burner flames should look the same with circulation blower on and off. If not, move gas control slide switch to OFF position.
11. Turn off electricity disconnect switch located next to furnace. Disconnect all room thermostat wires at Control Module terminal strip. To start blower on heating speed, jump terminals “R” and “G”. Turn on electricity at electrical disconnect switch next to furnace.
12. Check for air leaks between bulkhead and blower deck, under burners and up each side where bulkhead mounts to casing. Tighten screws until air leaks stop.
13. Turn off electricity at electrical disconnect switch located next to furnace. Remove jumper from terminal strip, terminals “R” and “G”. Reconnect all room thermostat wires to original terminal strip, terminals. See Section 16, Figure 5.
14. Remove the “U” tube water manometer from gas control and replace outlet pressure tap. Move gas control slide switch to ON position.
15. Set room thermostat to desired setting.

20. INLET GAS PRESSURE & PILOT ADJUSTMENT



You must have correct gas supply line and pilot gas pressures. Correct pressures give proper pilot ignition and burner operation. Use a "U" tube water manometer to measure actual gas pressure. Failure to accurately adjust pressure could cause a fire or explosion resulting in damage, injury or death.

A. Gas Supply Line Pressure

1. Turn OFF gas at manual shut-off valve in gas supply line just ahead of furnace.
2. Remove inlet pressure plug from gas control.
3. Make sure valve is in OFF position, then install 1/8" pipe manual shut-off valve in hole vacated by plug.
4. Attach "U" tube water manometer to 1/8" pipe manual shut-off valve just installed.
5. Open manual shut-off valve in gas supply line just ahead of furnace.
6. Open 1/8" pipe manual shut-off valve leading to "U" tube water manometer.
7. Turn on all gas appliances attached to gas supply line.
8. With furnace operating, read gas supply line pressure on manometer.
 - a) Gas supply line pressure must be between 5 - 7 in. W.C. for natural gas.
 - b) Gas supply line pressure must be between 11-13 in. W.C. for propane (LP) gas.
9. If gas supply line pressure is not within these limits, call gas supplier.
10. Turn off all gas appliances attached to gas supply line.

B. Pilot Flame Adjustment

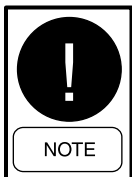

Pilot flame adjustment was checked at the factory and should not require adjustment. Under certain applications and conditions, pilot adjustment may be necessary.

Before adjusting pilot flame, confirm that gas supply line pressure is correct, as explained in paragraph "A" above, and then proceed:

1. Open manual shut-off valve located in gas supply line just ahead of furnace.

2. Start furnace following Operating Instructions on front door.
3. Pilot flame should cover 1/2" of tip of flame sensor as shown in Figure 6.

PILOT FLAME ADJUSTMENT

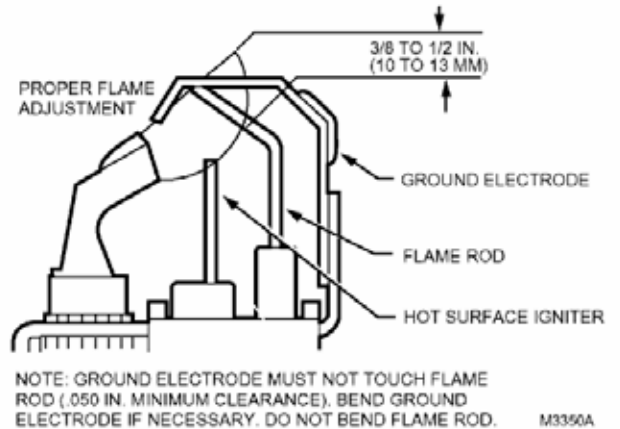

Fig. #6 - PILOT FLAME ADJUSTMENT

4. If you need to adjust pilot flame, remove pilot adjustment cover screw on gas control. See cover screw for reinstallation. Turn inner adjustment screw clockwise to decrease pilot flame; counter clockwise to increase pilot flame. Install cover screw and tighten to torque of 5 inch-pounds to prevent gas leakage.
5. Shut OFF furnace.
6. If you will not be checking gas input now, turn off gas. Use manual shut-off valve in gas supply line just ahead of furnace. Remove shut-off valve from gas control inlet pressure tap. Install pressure tap plug. Turn on gas.
7. Check pilot adjustment cover screw and gas inlet pressure tap plug for gas leaks. Use a commercial soap solution made for leak detection.

21. ADJUSTING MANIFOLD PRESSURE



Correct manifold pressure is necessary for proper ignition and burner operation. Use a "U" tube water manometer to measure actual gas pressure. Failure to accurately adjust pressure could cause heat exchanger failure, asphyxiation, fire or explosion resulting in damage, injury or death.

A. Normal manifold pressures (gas control outlet pressures).

Gas Supply	Normal
Natural Gas	3.5 inches W.C.
Propane (LP) Gas	9.5 inches W.C.



Do not set manifold pressure for propane (LP) at 11.0 inches. It could cause heat exchanger failure.

Check gas supply pressure first, following instructions in Section 20A.

B. Connect a "U" tube water manometer to measure manifold pressure:

1. Turn OFF gas at manual shut-off valve located in gas supply line just ahead of furnace.
2. Remove outlet pressure tap plug from gas control.
3. Make sure shut-off valve is in OFF position, then install 1/8" pipe manual shut-off valve in hole vacated by plug.
4. Attach "U" tube water manometer to 1/8" pipe manual shut-off valve just installed.
5. Turn on all gas appliances attached to gas supply line.
6. Open manual shut-off valve in gas supply line just ahead of furnace. Start furnace following Operating Instructions on front door.
7. Open 1/8" pipe manual shut-off valve leading to manometer.
8. Read manifold pressure on manometer.
9. Make small changes in manifold pressure, within allowable range (3.2 inches W.C. to 3.8 inches W.C. for natural gas, 9.2 inches W.C. to 9.8 inches W.C. for propane), by turning gas control regulator adjusting screw clockwise to increase pressure; turn counter clockwise to decrease pressure. Major changes in flow rate can only be made by changing main burner orifice size. See Section 24.
10. Shut OFF furnace. Turn OFF gas at manual shut-off valve in gas supply line just ahead of furnace. Install outlet pressure tap plug in gas control. Turn ON gas.

11. Check regulator adjustment cover screw and gas control plug for gas leaks. Use a commercial soap solution made for leak detection.

22. CHECKING GAS INPUT



Natural gas heating values (BTU/cu.ft.) can vary significantly. Therefore, it is the installers' responsibility to see that the BTU input does not exceed the rating of the furnace. Failure to do so could cause heat exchanger failure, asphyxiation, fire or explosion resulting in damage, injury or death.

Under-firing could cause inadequate heat, excessive condensation or ignition problems. Over-firing could cause sooting, flame impingement or overheating of heat exchanger.

A. Natural Gas

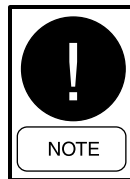

For furnace operation above 2,000 feet elevation, follow instructions in Section 24.

Before starting natural gas input check, obtain gas heat value at standard conditions from local supplier.

1. Make sure gas piping is large enough for all appliances connected to it to operate at once without lowering main line pressure. Failure to do so could cause lighting or burning problems on any of the appliances.
2. Make sure gas control inlet pressure does not exceed 10.5 inches W.C. Use method in section 20A to check gas supply line pressure.
3. Make sure all other gas appliances are off. You may leave pilots on. Start furnace following Operating Instructions on front door or in Users' Information Manual.
4. As furnace warms up, watch gas supply line (gas control inlet) pressure using "U" tube water manometer installed in gas control inlet pressure tap. Natural gas supply line pressure must still not exceed 10.5 inches W.C.
5. After verifying correct gas control inlet pressure, close shut-off valve in gas control inlet pressure tap. Move manometer connection to gas control outlet pressure tap. See Section 21. Open shut-off valve in outlet pressure tap. Let furnace warm up for 6 minutes.

6. Manifold pressure should be 3.5 inches W.C. Adjust by removing regulator cover screw on gas control. Save cover screw for reinstallation. Turn inner adjustment screw counter-clockwise to decrease manifold pressure; turn clockwise increase manifold pressure. Set correct manifold pressure. Install cover screw and tighten to torque of 5 inch-pounds to prevent gas leakage.
7. Locate gas meter. Determine which dial has the least cubic feet of gas and how many cubic feet per revolution it represents. This is usually one-half, one or two cubic feet per revolution.
8. With stopwatch, measure time it takes to consume two cubic feet of gas.
 - a) If dial is 1/2 FT³ / revolution, measure time for four revolutions.
 - b) If dial is 1 FT³ / revolution, measure for two revolutions.
 - c) If dial is 2 FT³ / revolution, measure for one revolution.
 - d) After determining the number of seconds for two cubic feet of gas to flow through meter, divide this time by two. This gives average time for one cubic foot of gas to flow through meter.

Example: If it took 58 seconds for two-cubic feet to flow, it would take 29 seconds for one-cubic foot to flow.

9. Use this formula to calculate gas input:

$$\text{Gas Input} = \frac{\text{Gas Btu/Cu. Ft.} \times 3,600 \text{ Seconds/Hour}}{\text{Seconds for one cubic foot of gas}} = \text{Btuh}$$

Example: Assume it took 56.25 seconds for one cubic foot of gas to flow and heating value of 1,000 BTU/CU.FT.

$$\text{Gas Input} = \frac{1,000 \times 3,600}{56.25} = 64,000 \text{ Btuh}$$

If you left no other pilots on, this is the furnace gas input.

If you left water heater, dryer or range pilots on, allow for them in calculating correct furnace gas input. A quick way is to allow 1,000 Btuh for a water heater. Allow 500 Btuh for dryer and 500 Btuh for each range burner pilot.

Example: If you left gas water heater, dryer, four range burner pilots and one oven pilot on, allow:

Water heater pilot	1,000 Btuh
Dryer pilot	500 Btuh
4 range burner pilots	2,000 Btuh
1 range oven pilot	500 Btuh
	<u>4,000 Btuh</u>

Subtracting 4,000 Btuh from 64,000 Btuh measured above equals 60,000 Btuh. This would be the correct furnace gas input after allowing for pilots left on.

10. Manifold pressure may be adjusted within the range of 3.2 inches W.C. to 3.8 inches W.C. to get rated input. If you cannot get rated input with manifold pressure within the allowable range, you will need to change orifices. See Section 23.
11. Turn off gas. Remove 1/8" pipe manual shut-off valves you used. Install 1/8" pipe plugs in gas control inlet and outlet pressure taps. Tighten to torque of 50 inch-pounds. Turn on gas. Check both pipe plugs for gas leaks. Use a commercial soap solution made for leak detection.

B. Propane (LP) Gas.



Propane (LP) gas installations do not have gas meters to double-check input rate. Measure manifold pressure adjustments with an accurate "U" tube water manometer. Failure to accurately adjust pressure could cause heat exchanger failure, asphyxiation, fire or explosion, resulting in damage, injury or death.



For furnace operation at elevations above 2,000 feet, follow instructions in Section 24.

1. Make sure you have correct pilot orifice and main burner orifices. Be sure that gas piping is large enough for all appliances connected to it to operate at once without lowering the main line pressure. Failure to do so could cause lighting or burning problems on any of the appliances.
2. Gas control inlet pressure must be between 11 inches and 13 inches for propane (LP) gas. See Section 20A to check gas supply line for pressure.

3. Turn off all other gas appliances. Pilots may be left on. Start furnace following Operating Instructions on front door or in Users' Information Manual.
4. As furnace warms up, watch gas supply line (gas control inlet pressure) using "U" tube water manometer in gas control inlet pressure tap. See Section 20A. Supply line pressure must still be between 11 inches and 13 inches W.C. for propane (LP) gas.
5. After verifying correct gas control inlet pressure, close shut-off valve in gas control inlet pressure tap. Move manometer to gas control outlet pressure tap. See Section 24. Open shut-off valve in gas control outlet pressure tap. Let furnace warm up for approximately 6 minutes.
6. Manifold pressure should be 9.5 inches W.C. +/-0.3 inches W.C. Adjust by removing regulator cover screw on gas control. Save cover screw for reinstallation. Turn inner adjustment screw counter-clockwise to decrease manifold pressure, turn clockwise to increase manifold pressure. Set correct manifold pressure. Install cover screw and tighten to torque of 5 inch-pounds to prevent gas leakage.



Many installers set propane (LP) manifold pressure at 11.0 inches W.C. DO NOT DO THIS! It could cause heat exchanger failure or nuisance callbacks.

7. Turn off gas before removing the 1/8" pipe manual shut-off valves. Install 1/8" pipe plugs in gas control inlet and outlet pressure taps. Tighten to torque of 50 inch-pounds. Turn on gas. Check both pipe plugs for gas leaks. Use commercial soap solution made for leak detection.

23. ORIFICE SIZE

See Figure #7 for initial gas orifice sizes as shipped from factory. Check with your local gas supplier to determine heat value (BTU/CU.FT) of gas in your area. Depending on your local heat value and elevation, you may need to adjust manifold pressure or change orifices to get proper gas input rate. See Section 24.

INITIAL ORIFICE SIZE		
Input BTU/Hr.	Natural Gas Orifice Size*	Propane Orifice Size
All Size Units	2.15 mm	1.35 mm
2,000'-4,500' Above Sea Level	2.05 mm	1.30 mm

* See furnace rating plate located on blower door.

Fig. #7 - PILOT FLAME ADJUSTMENT

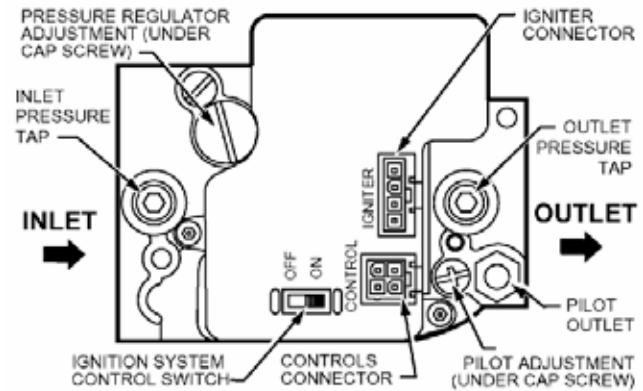

LD13388

Fig. #8 - IGNITION SYSTEM CONTROL

24. DERATING FOR HIGH ALTITUDES

A. Installer responsibility

For operation at elevations above 2,000 feet the density of air is reduced, therefore, the furnace should be derated at the rate of four percent (4%) for each 1,000 feet above 2,000 feet of elevation. It is the installers responsibility to see that the input is adjusted properly. In Canada, derate 10% for elevations for 2,000 to 4,500 feet.

If the gas supplier has not already derated the gas BTU valve, derating must be achieved by reducing the size of the main burner orifices. Contact gas supplier for more information on proper sizing.

Adjustment of the manifold pressure to a lower pressure reading than what is specified in Section 21, (Manifold Pressure Adjustment) of this manual is considered to be an improper derate procedure. With a lower density of air and a lower manifold pressure at the burner orifice, the orifice will not aspirate the proper amount of primary air into the burner. Insufficient primary air can cause incomplete combustion, yellow tipping and the possibility of carbon build-up.

B. New orifice size (2,000 to 4,500 feet)

To accomplish altitude derate, an orifice kit containing the required natural gas orifices is available through your furnace supplier (for Canadian installations only). A similar propane (LP) gas orifice kit is also available. Individual orifices are also available in a convenient lot size. Use only the designated orifices to assure proper performance. The natural gas orifice changes to 2.05 mm, while the propane (LP) orifice changes to 1.30 mm.

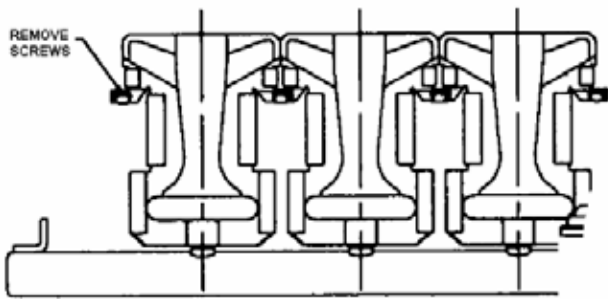

Fig. #9- CHANGING ORIFICES

LD13390

C. Changing orifices.



Before changing orifices, turn off electrical power and gas. Failure to do so could result in electrical shock or gas leak, resulting in damage, injury or death.

1. Set room thermostat to its lowest or off setting.
2. Turn off electricity at electrical disconnect switch next to furnace.
3. Turn off manual shut-off valve in gas supply line just ahead of furnace.
4. Move gas control slide switch to OFF position.
5. Starting with burner farthest from gas control, remove burner screws and burners. Burners overlap. Burner farthest from gas control is on top. See Figure #9.
6. Remove original gas orifices.
7. Hand-tighten new orifices into manifold; do not cross-thread. Then tighten to torque of 50 inch-pounds.
8. Replace burners in reverse order from instructions in Step 5.
9. Check burner carryover alignment. They should touch but not overlap adjacent burner. Replace screws.
10. Move gas control slide switch to ON position.
11. Open manual shut-off valve in gas supply line just ahead of furnace.
12. Set room thermostat to its highest setting.
13. Turn on electricity at electrical disconnect switch located next to furnace.
14. Check for gas leaks using commercial soap solution made for leak detection.
15. Check gas input as per instructions in Section 22.

25. SYSTEM BALANCE



High duct work static pressure may cause low airflow resulting in poor heating performance and reduced heat exchanger life. Low airflow may also cause poor cooling performance.

A. Preparing to measure ductwork static pressure.

- 1) Open supply air registers and return air grilles. Make sure the registers and grilles are free of obstruction from rugs, carpets, drapes or furniture.
- 2) Set balancing dampers in supply duct system.
- 3) Check ductwork for obstructions or leaks.
- 4) Make sure filters are clean and in place. See Section 15 for filter information.
- 5) Blower speed taps are set for proper heating and cooling speed.

a. Heating

- i) Measure ductwork static pressure with circulating air blower on heating. Follow instructions in "B", below.
- ii) Measure heating air temperature rise.

b. Air Conditioning

Measure ductwork static pressure with circulating air blower on air conditioning. Follow instructions in "B", below.

B. Measuring duct work static pressure

- 1) Place slope gauge near furnace where level, and adjust scale to read 0.00 inches W.C
- 2) Insert one static pressure tap into the supply air plenum. Insert other static pressure tap in return air duct on the air entering side of the filter.
- 3) Connect pressure tap attached to supply air duct or warm air supply plenum to positive pressure side of slope gauge.
- 4) Connect pressure tap attached to return air duct to negative pressure side of slope gauge.
- 5) Start blower
 - a. Heating speed blower can be run by jumping terminals "R" and "G" on 24 volt terminal block located on the Control Module.
 - b. Cooling speed blower can be run by jumping terminals "R" and "Y" on 24 volt terminal block located on the Control Module.

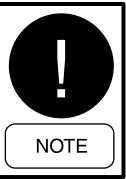

On cooling speed, there will be a 4 second on-delay before the blower will start and a 100 second off-delay before the blower will stop.

- 6) With blower running, read ductwork static pressure from slope gauge.
- 7) Ductwork static pressure should not exceed 0.3 inches W.C. in order to ensure proper volume of airflow.
- 8) Remove jumper wire from 24-volt terminal strip. Remove pressure taps and seal holes in duct work. Failure to seal holes could result in reduced system performance.

26. MEASURING AIR TEMPERATURE RISE

Factory Settings for Blower Speeds:

Unit Model	Temp Rise °F	Heating Cycle	Cooling Cycle
*GAD201212	30-60	Medium-Low	Medium-High
*GAD401212	35-65	Medium	Low
*GAD401812	35-65	Medium	Medium
*GAD601812	50-80	High	Medium
*GAD402412	35-65	Low	Medium
*GAD602412	50-80	Medium	Medium
*GAD603012	50-80	Low	High
*GAD803612	60-90	Medium	High



If the blower speed is changed from the above factory settings, the temperature rise must be checked to make sure it is still within the range shown above and on the unit data label.

A. Preparing to measure air temperature rise.

Follow steps 1 through 5 in Section 25A of this manual, under "System Balance".

B. Measuring air temperature rise.

Air temperature rise (warm air supply temperature minus cold air return temperature) must be within allowable air temperature rise range specified on furnace rating plate.

- 1) Place thermometer in supply air approximately 2 feet from plenum. Position thermometer so that it is not affected by radiant heat from the heat exchanger.
- 2) Place thermometer in return air duct approximately 2 feet from furnace. Locate thermometer tip in center of duct to ensure proper temperature measurement.
- 3) Set room thermostat on highest temperature setting. Operate furnace 6 minutes. Record supply air and return air temperature.
- 4) Calculate air temperature rise by subtracting return air temperature from supply air temperature.
- 5)
 - a) If air temperature rise is below maximum temperature rise, heating system has sufficient airflow.
 - b) If air temperature rise is above maximum temperature rise specified on the nameplate, gas input may be too high. Check gas input following the instructions in Section 22.
 - c) If air temperature rise is still above maximum temperature rise specified, more heating airflow is needed.



Operating furnace above maximum air temperature rise may cause poor heating performance and decreased heat exchanger life.

- 6) Heating speed tap should not normally be reduced below initial factory setting. Some duct system configurations and supply register locations may result in "cold blow".
- 7) After making heating airflow adjustments, you must check air temperature rise following steps 3 & 4 above to verify that resulting air temperature is within allowable range.
- 8) If air temperature rise is still above that specified on furnace rating plate, check ductwork design with a qualified heating engineer. It may be necessary to resize the ductwork. Recheck air temperature rise after revising duct system.
- 9) Set room thermostat to desired setting.
- 10) Remove thermometers and seal ductwork holes. Failure to seal

27. MAINTAINING FURNACE IN GOOD WORKING ORDER



Follow these procedures before inspecting furnace.

- Turn room thermostat to its lowest or off setting.
- Turn off manual gas shut-off valve.
- Wait at least five minutes for furnace to cool if it was recently operating.
- Turn off furnace electrical power; failure to do so could result in injury or death.



Use only replacement parts listed in parts list. Failure to do so could impair furnace operation, resulting in damage, injury or death.

Perform periodic preventive maintenance once before heating season begins and once during heating season. Inspect, clean and repair as needed the following items:

1. The heat exchanger and flue gas passageways of the furnace should not require cleaning if the furnace has been operating normally. If a build up of soot is found in the heat exchanger or the flue gas passageways, this indicates incomplete combustion. Check gas pressures at the inlet and manifold test ports on the gas valve. Check that the main burner orifices are correct for the quality of gas and the altitude. Check that the ventor motor is in good working order and that there is no obstruction of combustion air in or out of the furnace. The cause of the soot build up should be diagnosed and corrected. The heat exchanger can be cleaned if necessary by a probe such as is used to clear household drains. Insert the probe into the outlet end of each tube and feed it through until it comes out of the inlet or burner end of the heat exchanger tube. Any soot dislodged can be removed from the burner end of the tubes with a vacuum cleaner.
2. All burners, pilot, collector box, draft inducer assembly and complete vent system. Vent system must not be loose and must not have holes or cracks.
3. All gas pipes leading to furnace.
4. All electrical wiring and connections, including electrical ground.

5. All supply air and return air ducts for obstructions, air leaks and loose insulation.
6. Blower housing, motor and wheel, air filters, and draft inducer motor. Blower motor and inducer motor do not require oiling.

A qualified service technician should follow these steps to remove the indoor circulating blower assembly.

- a) Disconnect room thermostat wires from 24-volt terminal strip on Control Module.
- b) Locate the five blower motor wires that feed through the casing hem. Disconnect the wires from the Control Module.



Label blower motor wires before removal from the Control Module to ensure proper replacement.

- c) Remove blower door.
 - d) Pull blower motor wires through casing hem.
 - e) Remove screws holding blower assembly to blower deck.
 - f) Slide blower assembly out of unit cabinet.
 - g) After cleaning blower assembly, re-assemble in reverse order making sure speed selections are in their original positions.
7. Assure that the furnace is operating properly and safely.

28. GETTING OTHER INFORMATION & PUBLICATIONS

These publications can help you install the furnace. You can usually find these at your local library or buy them directly from the publisher. Be sure to consult current edition of each standard.

Gas-Fired Central Furnaces:

AGA/ANSI Z21.47, CAN/CGA-2.3

Heating & Cooling Equipment:

UL1995, CAN/CSA-C22.2 No.236

Natural Gas, and Propane Installation Codes:

CAN/CGA-B149.1, CAN/CGA-B149.2

U.S. National Fuel Gas Code:

ANSI Z223.1/NFPA 54

U.S. National Electrical:

ANSI/NFPA Code 70

Standard for the Installation of Warm Air Heating & Air Conditioning Systems:

ASHRAE/NFPA 90

FOR MORE INFORMATION, CONTACT THESE PUBLISHERS:**ANSI: American National Standards Institute**

1430 Broadway
 New York, NY 10018
 (212) 354-3300

ASHRAE: American Society of Heating Refrigerating & Air Conditioning Engineers:

1791 Tullie Circle N.E.
 Atlanta, GA 30329
 (404) 636-8400

NFPA: National Fire Protection Association

Batterymarch Park
 Quincey, MA 02269
 (617) 770-3000

CSA: Canadian Standards Association

178 Rexdale Boulevard
 Toronto, Ontario
 Canada M9W 1R3
 (416) 747-4000

29. REFRIGERANT CHARGES

All units are charged at the factory with R22.

Unit Cooling Capacity (BTU/HR.)	Refrigerant Charge
12,000 2lb.	14oz.
18,000 3lb	8oz.
24,000 4lb.	8oz.
30,000 4lb	14oz.
36.000 5lb.	12oz.

30. WIRING CONNECTION DIAGRAM

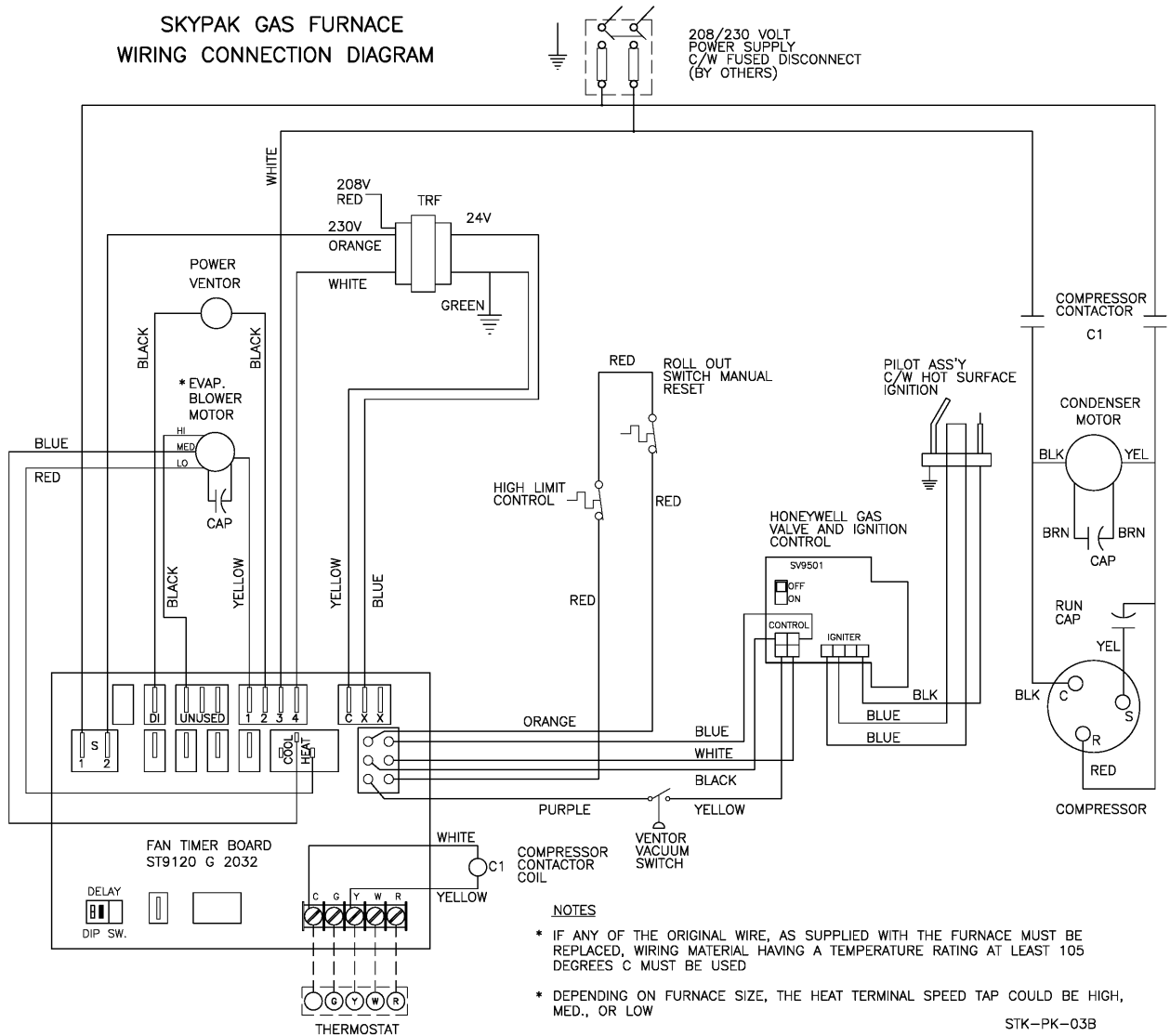

LD13593

31. SCHEMATIC WIRING DIAGRAM

SKYPAK GAS FURNACE
SCHEMATIC WIRING DIAGRAM
208/230V

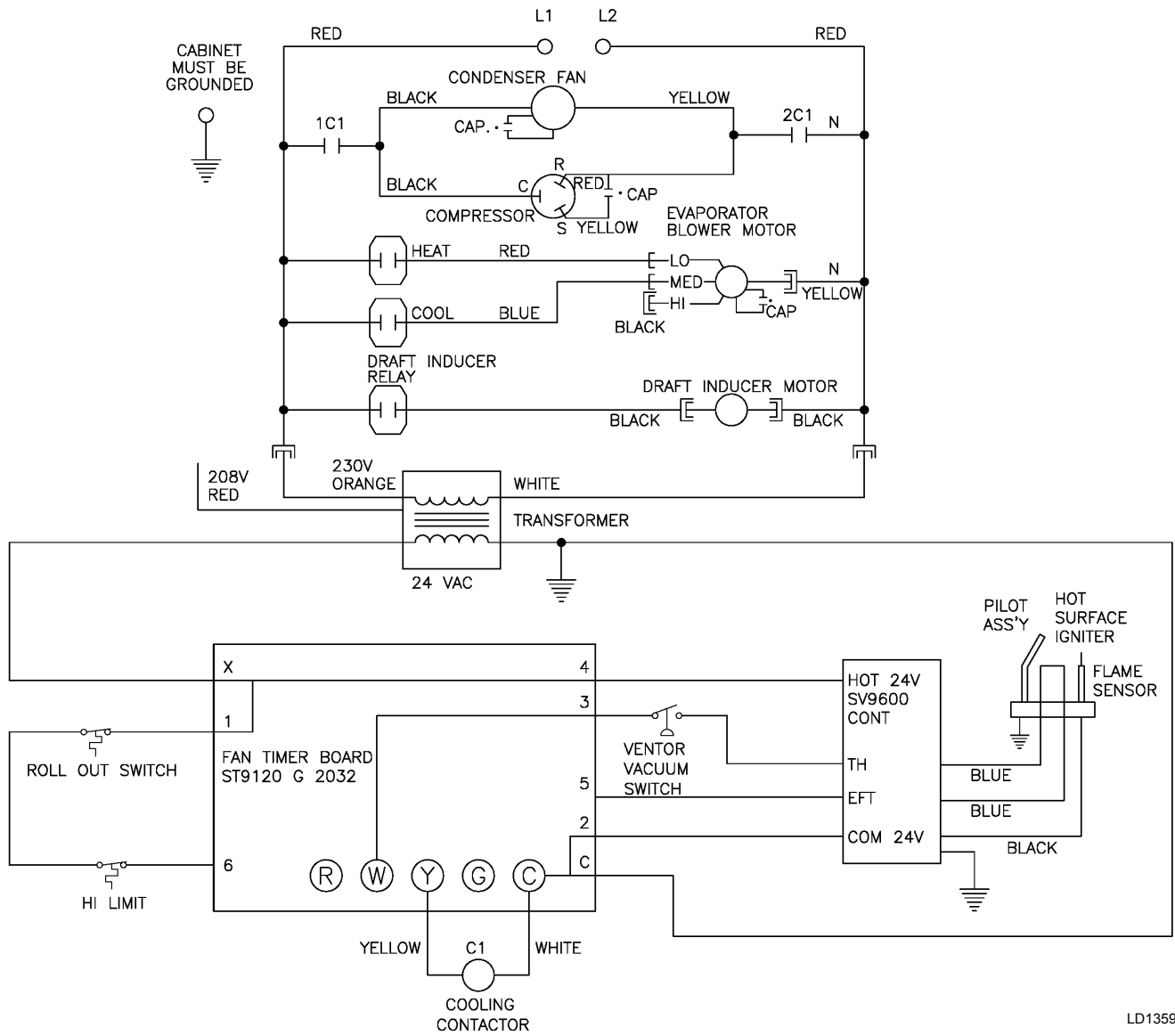

LD13594

32. IGNITION SYSTEM TROUBLESHOOTING GUIDE

SV9501/SV9502 SmartValve™ TROUBLESHOOTING SEQUENCE

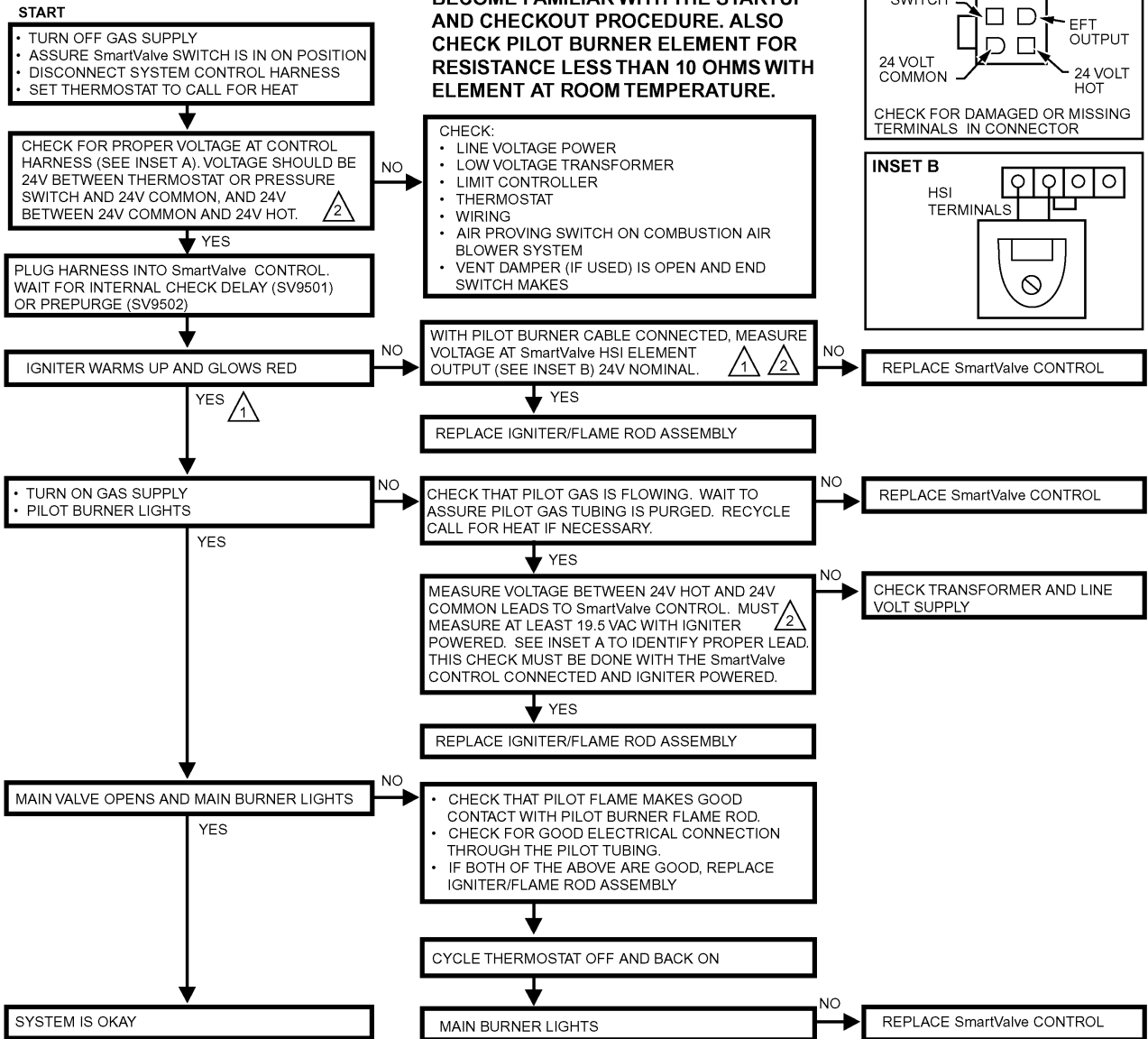

¹ IGNITER WILL CYCLE OFF AND BACK ON ONCE DURING THE 90 SECOND IGNITION TRIAL. ALL VOLTAGE MEASUREMENTS MUST BE TAKEN WHILE THE IGNITER IS POWERED.

² WHEN MEASURING VOLTAGE AT CONNECTIONS, USE CARE TO ASSURE TERMINALS ARE NOT DAMAGED.

M17143

LD13595

33. DIRECT VENT FURNACES - VENT TERMINAL CLEARANCES

		Canadian Installations ¹	US Installations ²
A =	Clearance above grade, veranda, porch, deck, or balcony	12 inches (30 cm)	12 inches (30 cm)
B =	Clearance to window or door that may be opened	12 inches (30 cm) for appliances > 10,000 Btuh (3 kW) and ≤ 100,000 Btuh (30 kW)	9 inches (30 cm) for appliances > 10,000 Btuh (3 kW) and ≤ 50,000 Btuh (15 kW), 12 inches (91 cm) for appliances > 50,000 Btuh (15 kW)
C =	Clearance to permanently closed window	*	*
D =	Vertical clearance to ventilated soffit located above the terminal within a horizontal distance of 2 feet (61 cm) from the center line of the terminal	*	*
E =	Clearance to unventilated soffit	*	*
F =	Clearance to outside corner	*	*
G =	Clearance to inside corner	*	*
H =	Clearance to each side of center line extended above meter / regulator assembly	3 feet (91 cm) within a height 15 feet (4.5 m) above the meter/regulator assembly	*
I =	Clearance to service regulator vent outlet	3 feet (91 cm)	*
J =	Clearance to nonmechanical air supply inlet to building or the combustion air inlet to any other appliance	12 inches (30 cm) for appliances > 10,000 Btuh (3 kW) and ≤ 100,000 Btuh (30 kW)	4 feet (1.2m) below or to side of opening: 1 foot (30 cm) above opening
K =	Clearance to a mechanical air supply inlet	6 feet (1.83m)	3 feet (91 cm) above if within 10 feet (3 m) horizontally
L =	Clearance above paved sidewalk or paved driveway located on public property	7 feet (2.13m) †	7 feet (2.13m)
M =	Clearance under veranda, porch deck, or balcony	12 inches (30 cm) ‡	*

¹ In accordance with the current CSA B149.1 Natural Gas and Propane Installation Code

² In accordance with the current ANSI Z223.1/NFPA 54, National Fuel Gas Code

† A vent shall not terminate directly above a sidewalk or paved driveway that is located between two single family dwellings and serves both dwellings

‡ Permitted only if veranda, porch, deck, or balcony is fully open on a minimum of two sides beneath the floor.

*CLEARANCE IN ACCORDANCE WITH LOCAL INSTALLATION CODES AND THE REQUIREMENTS OF THE GAS SUPPLIER AND THE MANUFACTURER'S INSTALLATION INSTRUCTIONS (DEGAGEMENT CONFORME AUX CODES D'INSTALLTION LOCAUX, AUX EXIGENCES DU FOURNISSEUR DE GAZ ET AUX INSTRUCTIONS D'INSTALLATION DU FABRICANT)

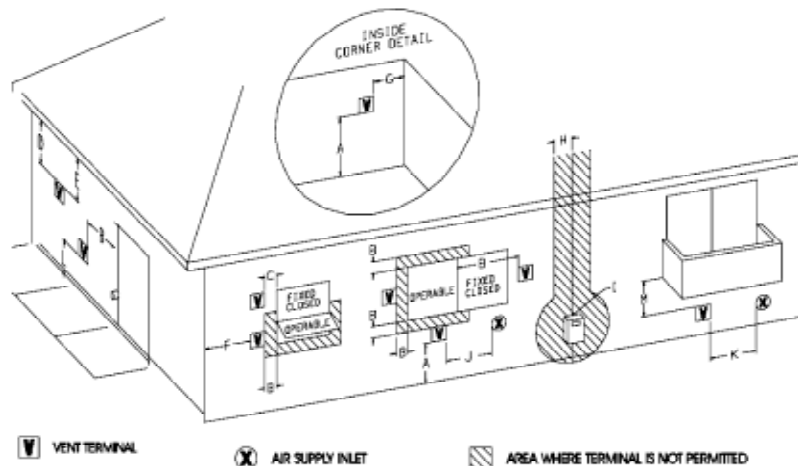

LIMITED WARRANTY – RGAC, SGAC FURNACE / AIR CONDITIONER

Johnson Controls warrants this product to be free from defects in workmanship or material for a period of one year from date of original installation or 18 months from date of shipment, whichever comes first

Johnson Controls obligation under this Warranty is LIMITED to repairing or replacing at our sole option, at our factory, any part thereof which shall be returned to our factory, transportation charges prepaid and which on examination proves to have been thus defective under normal domestic use not exceeding the fuel rating. The defective part should be returned through a qualified servicing dealer. Upon warranty determination, the replacement part will be shipped freight collect and assumes the unexpired portion of this Limited Warranty.

When a defective part can be repaired or replaced, Johnson Controls shall not be obligated to repair the entire unit or any part thereof other than the defective part.

This warranty applies only to the original homeowner, and is subject to the terms and conditions hereof.

COMPRESSOR – FIVE YEAR LIMITED WARRANTY

In addition to the One Year Limited Warranty, Johnson Controls warrants the compressor to be free from defects in workmanship or material for a period of five (5) years from the date of original installation. If a compressor fails during this five year period, a new compressor will be supplied. The customer will be responsible for freight costs from our factory for delivery of the replacement compressor and also for the return of the defective compressor which may be required under the terms of the Warranty. Labor and any other expense involved in replacing the compressor is not covered by this Warranty.

HEAT EXCHANGER – TEN YEAR LIMITED WARRANTY

In addition to the One Year Limited Warranty, Johnson Controls warrants the heat exchanger to be free from defects in workmanship for a period of ten (10) years from the date of original installation. During this time, a new replacement heat exchanger will be furnished, or at our sole option, a credit for the replacement heat exchanger may be allowed. Labor and other expenses involved in replacing the heat exchanger are not covered by this warranty. This Warranty applies only to the heat exchanger and not to other parts of the furnace, and only to the original homeowner, and is subject to the terms and conditions hereof.

LABOR AND COST NOT COVERED

This Warranty provides only replacement parts or credits, and does not provide for or cover any labor, shipping, handling or other costs for service travel, servicing, removing, or installing any parts.

EXCLUSIONS

This Warranty shall be void if:

1. The unit is not installed by a licensed or otherwise qualified or contractor and in compliance with the Installation Manual, applicable installation and good trade practices.
2. The defect or damage is caused by accident, abuse, negligence of any person or company, misuse, riot, flood, fire or Acts of God.
3. The unit is not operated and regularly serviced and maintained as called for in the Users' Manual.
4. Damages are caused by operating the unit in a commercial or corrosive atmosphere containing any damaging or dangerous chemicals.
5. The unit is modified or services in a manner not in accordance with the Installation Manual and Users' Manual.
6. Components, replacement parts, or other accessories not compatible with the unit or not approved by Johnson Controls have been used with or attached to the unit.
7. The defect or damage is not caused by Johnson Controls, or it arises from circumstances beyond the control of Johnson Controls.
8. The unit is installed outside the United States or Canada, or has been removed from the place where it was originally installed.

THIS WARRANTY IS IN LIEU OF ALL OTHER WARRANTIES, OBLIGATIONS OR LIABILITIES, EXPRESSED OR IMPLIED BY EMPLOYEES OR REPRESENTATIVES OF JOHNSON CONTROLS. ALL STATUTORY, EXPRESSED OR IMPLIED WARRANTIES, INCLUDING THE IMPLIED WARRANTY OF MERCHANTABILITY AND FITNESS FOR A PARTICULAR PURPOSE ARE HEREBY NEGATED AND EXCLUDED. ANY CLAIMS FOR INCIDENTAL AND CONSEQUENTIAL DAMAGES, OR ANY OTHER DAMAGES OR EXPENSES BEYOND THE TERMS OF THIS LIMITED WARRANTY ARE HEREBY EXPRESSLY NEGATED AND EXCLUDED.

